

# Getting started MICRO-EH

## High Speed Counter and PWM / Pulse train output

### 1. Introduction

All MICRO-EH with DC inputs are configurable for a mix of *High Speed Counter* (Up to 10 kHz). MICRO-EH with DC outputs are also be configured with *Pulse-Width Modulation Output* (Up to 2kHz) and *Pulse Train Output* (Up to 5 kHz) features. The mix of features available depends on the mode as listed below.

	<b>Mode 0</b> standard	<b>Mode 1</b> single counter x2	<b>Mode 2</b> single counter x4	<b>Mode 3</b> 2-phase counter x1 single counter x1
<b>X0</b>	standard (F)	<b>Counter 1 (F)</b>	<b>Counter 1 (F)</b>	<b>Counter 1A (F)</b>
<b>X1</b>	Interrupt 1 or Standard	Preload / Strobe input of counter 1 / ** Standard	Preload / Strobe input of counter 1 / ** Standard	Preload / Strobe input of 2-phase counter / ** Standard
<b>X2</b>	Standard (F)	<b>Counter 2 (F)</b>	<b>Counter 2 (F)</b>	<b>Counter 1B (F)</b>
<b>X3</b>	Interrupt 2 or Standard	Preload / Strobe input of counter 2 / ** Standard	Preload / Strobe input of counter 2 / ** Standard	<b>Counter 1Z (Marker) (F)</b>
<b>X4</b>	Standard (F)	Standard (F)	<b>Counter 3 (F)</b>	Standard (F)
<b>X5</b>	Interrupt 3 or Standard	Interrupt 3 or Standard	Preload / Strobe input of counter 3 / ** Standard	Interrupt 3 or Standard
<b>X6</b>	Standard (F)	Standard (F)	<b>Counter 4 (F)</b>	<b>counter 4 (F)</b>
<b>X7</b>	Interrupt 4 or Standard	Interrupt 4 or Standard	Preload / Strobe input of counter 4 / ** Standard	Preload / Strobe input of counter 1 / ** Standard
<b>Y100</b>	PWM 1 or Pulse output 1 or Standard	Counter output 1 or ** Standard	Counter output 1 or ** Standard	Counter output 1 or ** Standard
<b>Y101</b>	PWM 2 or Pulse output 2 or Standard	Counter output 2 or ** Standard	Counter output 2 or ** Standard	PWM 2 or Pulse output 2 or Standard
<b>Y102</b>	PWM 3 or Pulse output 3 or Standard	PWM 3 or Pulse output 3 or Standard	Counter output 3 or ** Standard	PWM 3 or Pulse output 3 or Standard
<b>Y103</b>	PWM 4 or Pulse output 4 or Standard	PWM 4 or Pulse output 4 or Standard	Counter output 4 or ** Standard	* PWM 4 / Pul. out 4 / Standard

**(F)** : The configuration is fixed. All others can be configured as standard or special in/output.

(\*) : Only for 10 points module.

(\*\*) : Added since ROM version 0110 (WRF051 = H0110)

## 2. Setting up

### Operation Mode

The following parameters must be set by a programming software or an operation panel **before CPU RUN**.

	Mode 0	Mode 1	Mode 2	Mode 3
WRF070	0	1	2	3
WRF071	Configuration for each in/output (Refer to page 3)			
WRF072	Freq. of PWM/pulse output 1 → FUN 148,150	On-preset value of counter 1 → FUN 146	On-preset value of counter 1 → FUN 146	On-preset value of 2-phase counter → FUN 146
WRF073	Freq. of PWM/pulse output 2 → FUN 148,150	On-preset value of counter 2 → FUN 146	On-preset value of counter 2 → FUN 146	Freq. of PWM/pulse output 2 → FUN 148,150
WRF074	Freq. of PWM/pulse output 3 → FUN 148,150	Freq. of PWM/pulse output 3 → FUN 148,150	On-preset value of counter 3 → FUN 146	Freq. of PWM/pulse output 3 → FUN 148,150
WRF075	Freq. of PWM/pulse output 4 → FUN 148,150	Freq. of PWM/pulse output 4 → FUN 148,150	On-preset value of counter 4 → FUN 146	On-preset value of counter 4 → FUN 146
WRF076	On duty of PWM output 1 → FUN 148	Off-preset value of counter 1 → FUN 146	Off-preset value of counter 1 → FUN 146	Off-preset value of 2-phase counter → FUN 146
WRF077	On duty of PWM output 2 → FUN 148	Off-preset value of counter 2 → FUN 146	Off-preset value of counter 2 → FUN 146	On duty of PWM output 2 → FUN 148
WRF078	On duty of PWM output 3 → FUN 148	On duty of PWM output 3 → FUN 148	Off-preset value of counter 3 → FUN 148	On duty of PWM output 3 → FUN 148
WRF079	On duty of PWM output 4 → FUN 148	On duty of PWM output 4 → FUN 148	Off-preset value of counter 4 → FUN 148	Off-preset value of counter 4 → FUN 146
WRF07A	Number of pulse output 1 → FUN 150	Pre-load value or storage register of counter 1	Pre-load value or storage register of counter 1	Pre-load value or storage register of 2-phase counter
WRF07B	Number of pulse output 2 → FUN 150	Pre-load value or storage register of counter 2	Pre-load value or storage register of counter 2	Number of pulse output 2 → FUN 150
WRF07C	Number of pulse output 3 → FUN 150	Number of pulse output 3 → FUN 150	Pre-load value or storage register of counter 3	Number of pulse output 3 → FUN 150
WRF07D	Number of pulse output 4 → FUN 150	Number of pulse output 4 → FUN 150	Pre-load value or storage register of counter 4	Pre-load value or storage register of counter 4
WRF07E		Rising/falling edge up/down counter → FUN 142	Rising/falling edge up/down counter → FUN 142	Rising/falling edge up/down counter → FUN 142
WRF06F				Phase counting mode (0-3)
R7F5	<b>Enable the above data (Necessary) [ Before CPU RUN ]</b>			
R7F6	Memory above information to FLASH ROM (kept during power OFF) [ Before CPU RUN ]			

#### [ Caution ]

- In case of High Speed Counter operation, if the On-preset value and the Off-preset value are the same (e.g. Both 0), the counter will not start counting. Even if the parameters are set properly by FUN command, the counter operation will not work unless default parameters are set before CPU RUN.
- If I/O is used as a standard one, the above setting is not necessary.
- Once these data is saved in FLASH ROM by setting R7F6 to high, no setting is necessary from next power ON.
- When writing FLASH ROM by setting R7F6 to high, it takes several seconds. While writing, **R7EF** is high.

## I/O configuration

Depending on the mode, configure each I/O in **WRF071**.

	15				8				7				0			
<b>WRF071</b>	a	b	c	d	e	f	g	h	i	j	k	l	m	n	o	p
	X1		X3		X5		X7		Y100		Y101		Y102		Y103	

Output		Mode 0	Mode 1	Mode 2	Mode 3
<b>X0</b>	-	Standard (F)	Counter 1 (F)	Counter 1 (F)	Counter 1A (F)
<b>X1</b>	<b>a b</b>	0 0	Standard	Counter 1 preload	Counter 1 preload
		0 1	Interrupt 1	Counter 1 strobe	Counter 1 strobe
		1 0	-	Standard	Standard
		1 1	-	-	-
<b>X2</b>	-	Standard (F)	Counter 2 (F)	Counter 2 (F)	Counter 1B (F)
<b>X3</b>	<b>c d</b>	0 0	Standard	Counter 2 preload	Counter 2 preload
		0 1	Interrupt 2	Counter 2 strobe	Counter 2 strobe
		1 0	-	Standard	Standard
		1 1	-	-	-
<b>X4</b>	-	Standard (F)	Standard (F)	Counter 3 (F)	Standard (F)
<b>X5</b>	<b>e f</b>	0 0	Standard	Standard	Counter 3 preload
		0 1	Interrupt 3	Interrupt 3	Counter 3 strobe
		1 0	-	-	Standard
		1 1	-	-	-
<b>X6</b>	-	Standard (F)	Standard (F)	Counter 4 (F)	Counter 4 (F)
<b>X7</b>	<b>g h</b>	0 0	Standard	Standard	Counter 4 preload
		0 1	Interrupt 4	Interrupt 4	Counter 4 strobe
		1 0	-	-	Standard
		1 1	-	-	-

Output		Mode 0	Mode 1	Mode 2		Mode 3	
<b>Y100</b>	<b>i j</b>	0 0	Standard	Counter output 1	Counter output 1	Counter output 1	
		0 1	PWM	Standard	Standard	Standard	
		1 0	Pulse	-	-	-	
		1 1	-	-	-	-	
<b>Y101</b>	<b>k l</b>	0 0	Standard	Counter output 2	Counter output 2	Standard	
		0 1	PWM	Standard	Standard	PWM	
		1 0	Pulse	-	-	Pulse	
		1 1	-	-	-	-	
<b>Y102</b>	<b>m n</b>	0 0	Standard	Standard	Counter output 3	Standard	
		0 1	PWM	PWM	Standard	PWM	
		1 0	Pulse	Pulse	-	Pulse	
		1 1	-	-	-	-	
<b>Y103</b>	<b>o p</b>	0 0	Standard	Standard	Co. out 4	Std. (*)	Co. out 4
		0 1	PWM	PWM	Std.	PWM (*)	Std.
		1 0	Pulse	Pulse	-	Pulse (*)	-
		1 1	-	-	-	-	-

(\*) Only for 10 points module

### < Binary → Hexadecimal >

0000 : H0	0100 : H4	1000 : H8	1100 : HC
0001 : H1	0101 : H5	1001 : H9	1101 : HD
0010 : H2	0110 : H6	1010 : HA	1110 : HE
0011 : H3	0111 : H7	1011 : HB	1111 : HF

### 3. High Speed Counter

The counter has an accumulator, a strobe register, Preload value and On/Off preset value as below. The counter output goes high when the accumulator value is between the preset on and off points. The counters run independently of the PLC status, RUN or STOP, as long as power is supplied.

This example shows how they work in case the Preload/Strobe input is configured for "Preload input".

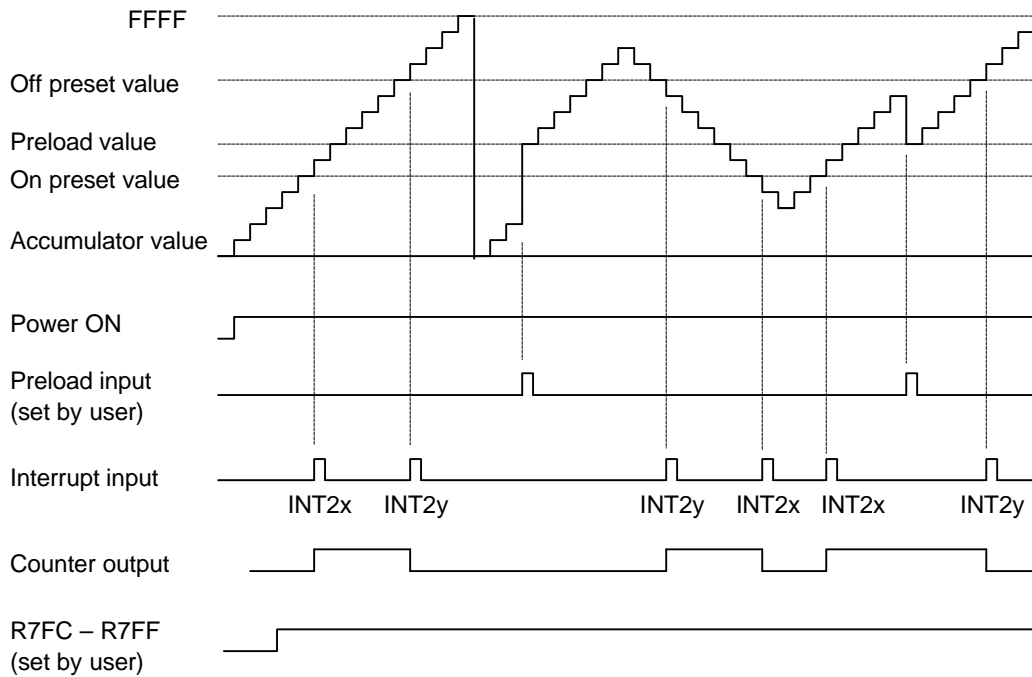

#### Enable / disable Counter output

If the counter output is used, enable the corresponding bit (R7FC-R7FF) by user program. If it needs to be used when the CPU is STOP, set the Output Enable bit to High after setting **R7DC** to High.

Description	Location	Enable	Disable
Output Enable bit for counter 1	R7FC	1	0
Output Enable bit for counter 2	R7FD		
Output Enable bit for counter 3	R7FE		
Output Enable bit for counter 4	R7FF		
<b>Outputs Enable when CPU STOP</b>	<b>R7DC</b>		

#### [ Caution ]

- The counter operation starts just after PLC power ON independent from CPU status. If you need to start counting after a certain condition fulfilled, use FUN 140 (start/stop counting) in user program.
- Depending on the configuration for Preload/Strobe, the Preload/Strobe input can either preload a value into the counted accumulator or strobe the accumulator value into a register (WRF07A-D). If the input configured for Preload input, when the Preload input goes high, the accumulator value changes into the Preload value. If the input configured for Strobe input, when the Strobe input goes High, the accumulator value will be stored in strobe register.

**Single phase counter**

Configure for rising/falling edge detection and up/down counter in **WRF07E** for each counter.

<b>WRF07E</b>	15				8				7				0
	a	b	c	d	e	f	g	h	any				
	1	2	3	4	1	2	3	4	-				

Counter 1 (X0)	a	0	Rising edge	e	0	Up counter
		1	Falling edge		1	Down counter
Counter 2 (X2)	b	0	Rising edge	f	0	Up counter
		1	Falling edge		1	Down counter
Counter 3 (X4)	c	0	Rising edge	g	0	Up counter
		1	Falling edge		1	Down counter
Counter 4 (X6)	d	0	Rising edge	h	0	Up counter
		1	Falling edge		1	Down counter

Default value : all 0

**2-phase counter**

Configure for Phase counting mode in **WRF06F**.

**[ Mode 0 : WRF06F = 0 ]**

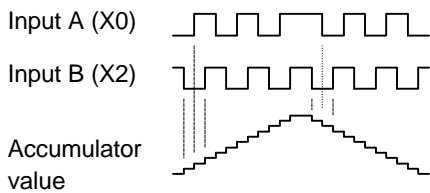

**[ Mode 1 : WRF06F = 1 ]**

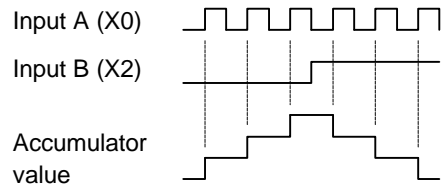

**[ Mode 2 : WRF06F = 2 ]**

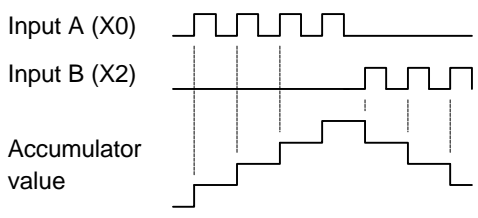

**[ Mode 3 : WRF06F = 3 ]**

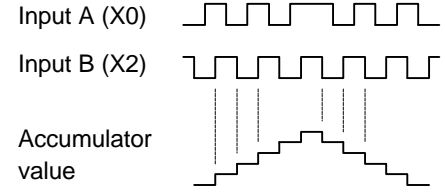

Default value : WRF06F = 0

## Counter interruption

When the accumulator value exceeds the On pre-set or Off pre-set value, an interruption processing can be executed in user program for each counter using INT command.

	On preset	Off preset
Counter 1	INT 20	INT 21
Counter 2	INT 22	INT 23
Counter 3	INT 24	INT 25
Counter 4	INT 26	INT 27

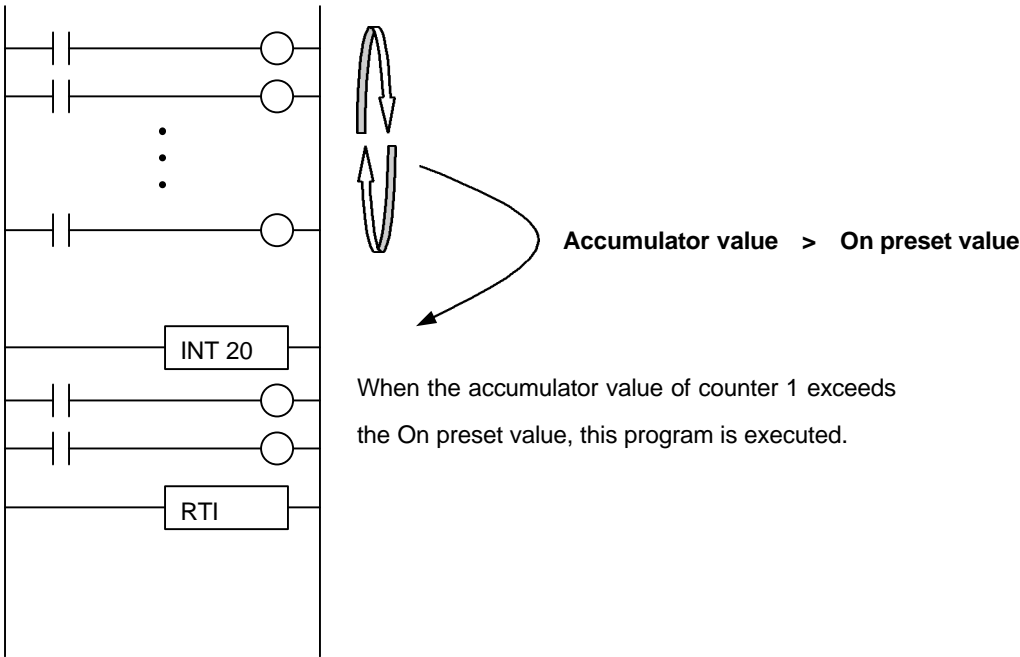

## 4. PWM output

PWM outputs can be used to control DC and stepper motors. The frequency of the PWM output is 10 Hz up to 2 kHz. Once a PWM output start operating, it continues until the Output Enable bit is cleared. PWM duty cycle is selected using the following addresses or FUN command. PWM frequency and duty cycle can be changed while the PWM output is operating.

	Setting	Address	Range	Output Enable bits
PWM output	Frequency (Hz)	WRF072-75	10 – 2000 (HA-H7D0)	R7FC-R7FF
	Duty cycle (%)	WRF076-79	0-100 (H0-H64)	

### Enable / disable PWM output

PWM output is operated by setting the Output enable bit to High. If it needs to be operated when the CPU is STOP, set the Output Enable bit to High after setting **R7DC** to High.

Description	Location	Enable	Disable
Output Enable bit for PWM output 1	R7FC	1	0
Output Enable bit for PWM output 2	R7FD		
Output Enable bit for PWM output 3	R7FE		
Output Enable bit for PWM output 4	R7FF		
<b>Outputs Enable when CPU STOP</b>	<b>R7DC</b>		

### Simple operation

According to the default parameter, PWM output is enabled from the user program by setting its Output Enable bit (R7FC – R7FF) to High.

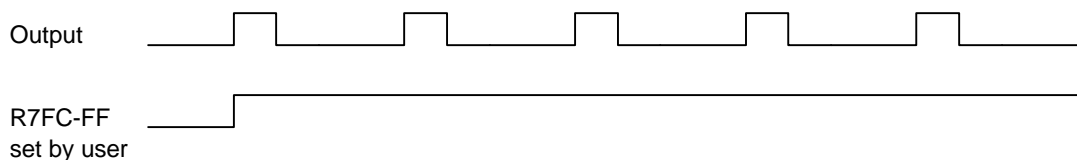

### FUN command operation

PWM output is enabled also by FUN command in the user program. In this case, R7FC-R7FF is set by system (CPU).

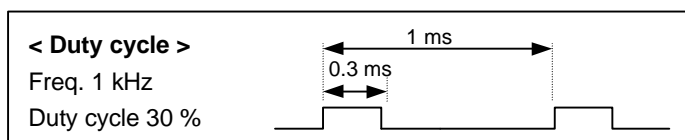
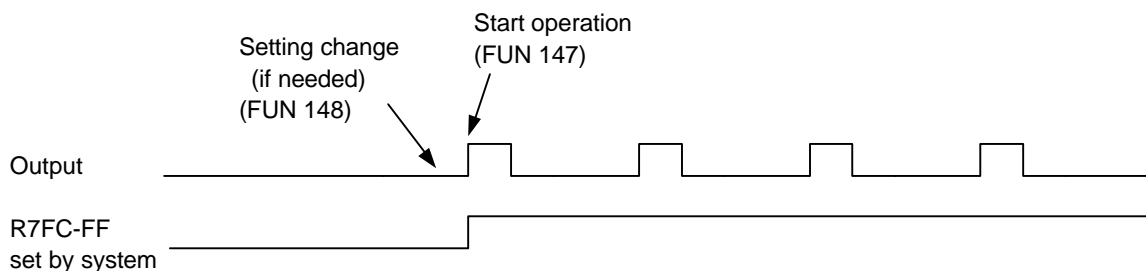

## 5. Pulse train output

Pulse train outputs can be used to control DC and stepper motors.

Pulse train output starts when its Output Enable bit is set to high. When the selected number of pulses has occurred, the Output enable bit is cleared. Pulse train output continues until it has completed or until the Output Enable bit is cleared. Pulse frequency can be changed while the pulse train is operating.

	Setting	Address	Range	Output Enable bits
Pulse train output	Frequency (Hz)	WRF072-75	10 – 5000 (HA-H1388)	R7FC-R7FF
	Number of pulses	WRF07A-7D	0-65535 (H0-HFFFF)	

[ **Caution** ] The total frequency of each pulse output must not exceed 5 kHz.

[ **Caution** ] Pulse train output is valid approx. 30 seconds after downloading due to system processing.  
(Flag R7EF is high while the system processing.)

### Enable / disable Pulse train output

Pulse train output is operated by setting the Output enable bit to High. If it needs to be operated when the CPU is STOP, set the Output Enable bit to High after setting **R7DC** to High.

Description	Location	Enable	Disable
Output Enable bit for Pulse train output 1	R7FC	1	0
Output Enable bit for Pulse train output 2	R7FD		
Output Enable bit for Pulse train output 3	R7FE		
Output Enable bit for Pulse train output 4	R7FF		
<b>Outputs Enable when CPU STOP</b>	<b>R7DC</b>		

### Simple operation

According to the default parameter, the Pulse train output is enabled from the user program by setting its Output Enable bit (R7FC – R7FF) to High.

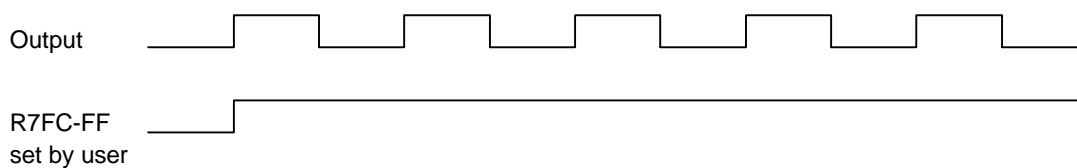

### FUN command operation

The Pulse train output is enabled also by FUN command in the user program. In this case, R7FC-R7FF is set by system (CPU).

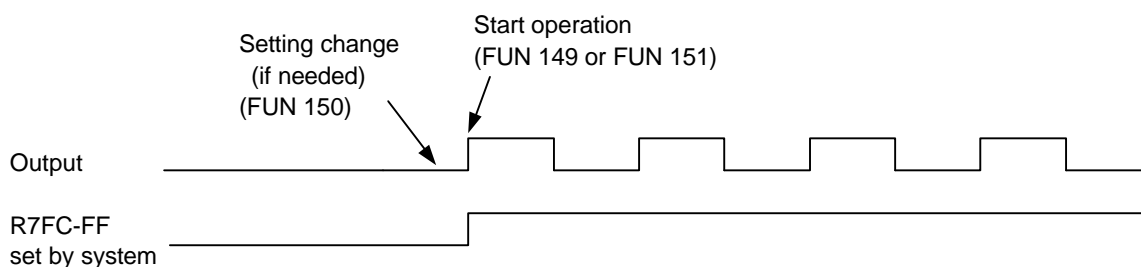



## 6. FUN command

While the CPU is RUN mode, each parameter can be changed by FUN command in user program.

High Speed Counter
--------------------

<b>Start/stop operation</b>	<b>FUN 140 (s)</b>	15	8	7	0
		s	Counter No. : H01 – H04	stop : H00 start : H01	
<b>Enable/disable counter output</b>	<b>FUN 141 (s)</b>	15	8	7	0
		s	Counter No. : H01 – H04	disable : H00 enable : H01	
<b>Up/down counter</b>	<b>FUN 142 (s)</b>	15	8	7	0
		s	Counter No. : H01 – H04	up counter : H00 down counter : H01	
<b>Write accumulator value</b>	<b>FUN 143 (s)</b>	15	8	7	0
		s	Counter No. : H01 – H04	any	
		s+1	Preload value		
<b>Read accumulator value</b>	<b>FUN 144 (s)</b>	15	8	7	0
		s	Counter No. : H01 – H04	any	
		s+1	( Stored here )		
<b>Clear accumulator value</b>	<b>FUN 145 (s)</b>	15	8	7	0
		s	Counter No. : H01 – H04	any	
<b>Set On/Off preset value</b>	<b>FUN 146 (s)</b>	15	8	7	0
		s	Counter No. : H01 – H04	Set On and Off : H00 Set On preset : H01 Set Off preset : H02	
		s+1	On preset value		
		s+2	Off preset value		

**PWM output**

**Start/stop operation FUN 147 (s)**

	15	8	7	0
s	PWM No. : H01 – H04		stop : H00 start : H01	

**Set Frequency, On duty FUN 148 (s)**

	15	8	7	0
s	PWM No. : H01 – H04		any	
s+1	Frequency (Hz) 10 – 2000 (HA-H7D0)			
s+2	On duty (%) 0-100 (H0-H64)			

**Pulse Train output**

**Start/stop operation FUN 149 (s)**

	15	8	7	0
s	Pulse output No. : H01 – H04		stop : H00 start : H01	

**Set Frequency, number of pulse FUN 150 (s)**

	15	8	7	0
s	Pulse output No. : H01 – H04		Set Freq. and Number : H00 Set Freq. : H01 Set number of pulse : H02	
s+1	Frequency (Hz) 10 – 5000 (HA-H1388)			
s+2	Number of pulse 0-65535 (H0-HFFFF)			

**Acceleration, Deceleration FUN 151 (s)**

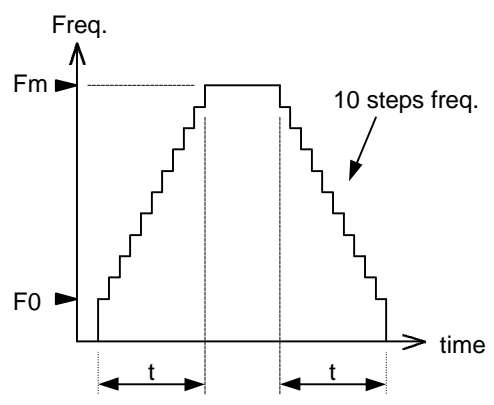

	15	8	7	0
s	Pulse output No. : H01 – H04		any	
s+1	Total number of pulse : "N" 0 – 65535 (H0-HFFFF)			
s+2	Max. Frequency (Hz) : "Fm" 10-5000 (HA-H1388)			
s+3	initial Frequency (Hz) : "F0" 10-5000 (HA-H1388)			
s+4	Acceleration time : "t" (= Deceleration time) (ms) 0-65535 (H0-HFFFF)			

Acceleration and deceleration are operated with 10 steps frequency as the figure shown left.

## 7. Error responses

If the parameters in WRF06F – WRF07E is invalid, it returns the following information in **WRF057**.

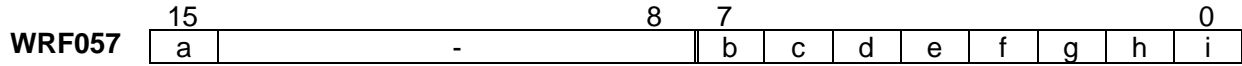

	Description	References
a	Total pulse frequency error	Y100 – Y103
b	Frequency error of pulse output 4	Y103
c	Frequency error of pulse output 3	Y102
d	Frequency error of pulse output 2	Y101
e	Frequency error of pulse output 1	Y100
f	On/Off preset value error of counter 4	X6
g	On/Off preset value error of counter 3	X4
h	On/Off preset value error of counter 2	X2
i	On/Off preset value error of counter 1 or 2-phase counter	X0 – X3

## 8. Examples

### High speed counter

- Mode 1
- X0 : Counter 1
- X1 : Counter strobe
- Y100 : Counter output
- Others : Standard I/O
- On preset value : H1000
- Off preset value : H7000

#### [ Configuration before CPU RUN ]

WRF070 = 1 (Mode)  
 WRF071 = H4000 (I/O configuration)  
 WRF072 = H1000 (On preset value)  
 WRF076 = H7000 (Off preset value)  
 R7F5 = 1 (Memory to CPU)

#### [ Program ]

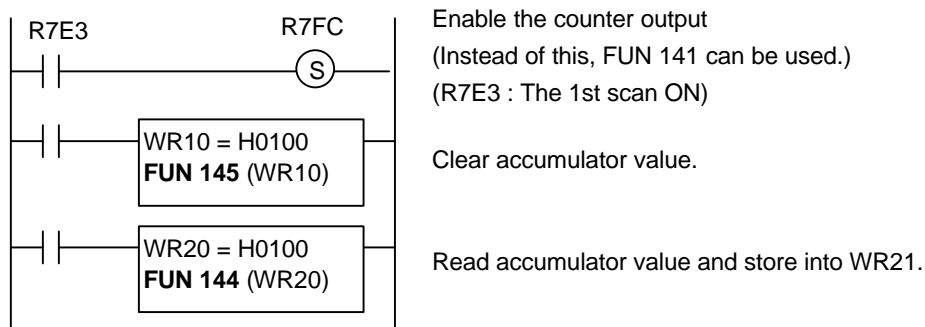

**PWM output**

- Mode 0
- Y101 : PWM output 2 (1 kHz, 45% → 2 kHz, 55%)
- Others : Standard I/O

**Example 1**

**[ Configuration before CPU RUN ]**

- WRF070 = 0 (Mode)
- WRF071 = H0010 (I/O configuration)
- WRF073 = 1000 (Frequency)
- WRF077 = 45 (Duty cycle)
- R7F5 = 1 (Memory to CPU)

**[ Program ]**

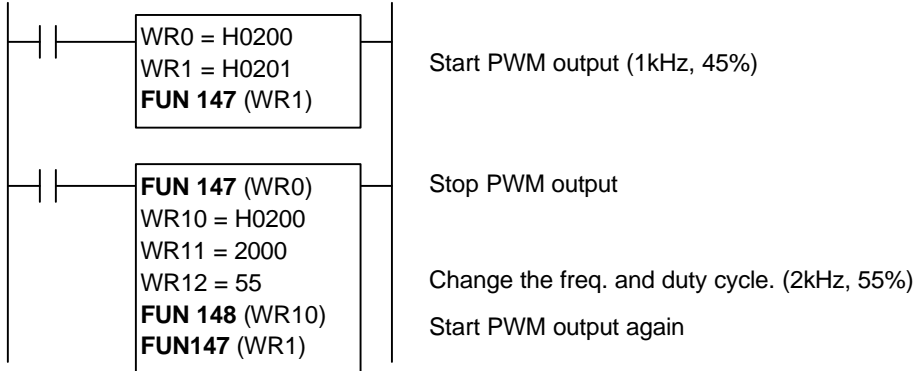

**Example 2**

**[ Configuration before CPU RUN ]**

- WRF070 = 0 (Mode)
- WRF071 = H0010 (I/O configuration)
- R7F5 = 1 (Memory to CPU)

**[ Program ]**

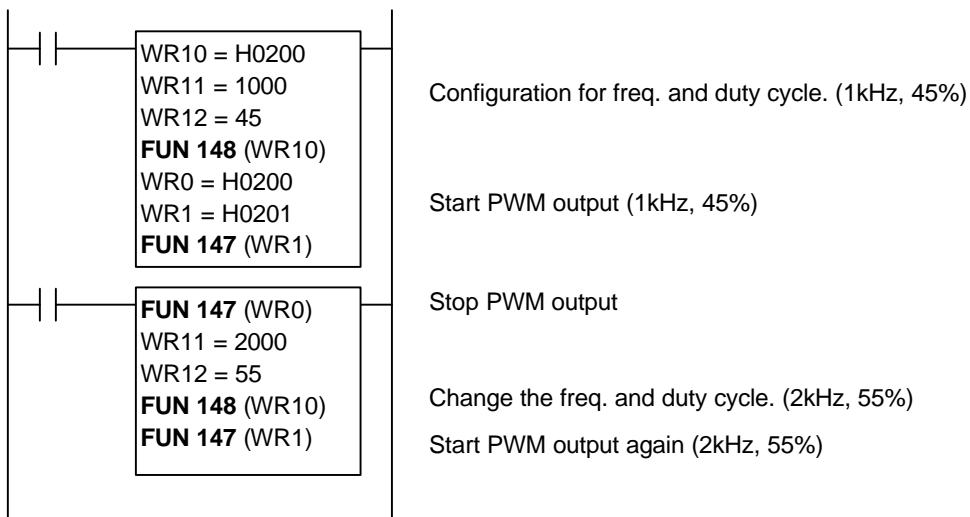

**Pulse train output**

- Mode 0
- Y102 : Pulse train output 3 (1 kHz, 500 pulses → 2 kHz, 800 pulses )
- Others : Standard I/O

**Example 1**

**[ Configuration before CPU RUN ]**

WRF070 = 0 (Mode)  
 WRF071 = H0008 (I/O configuration)  
 WRF074 = 1000 (Frequency)  
 WRF07C = 500 (Number of pulses)  
 R7F5 = 1 (Memory to CPU)

**[ Program ]**

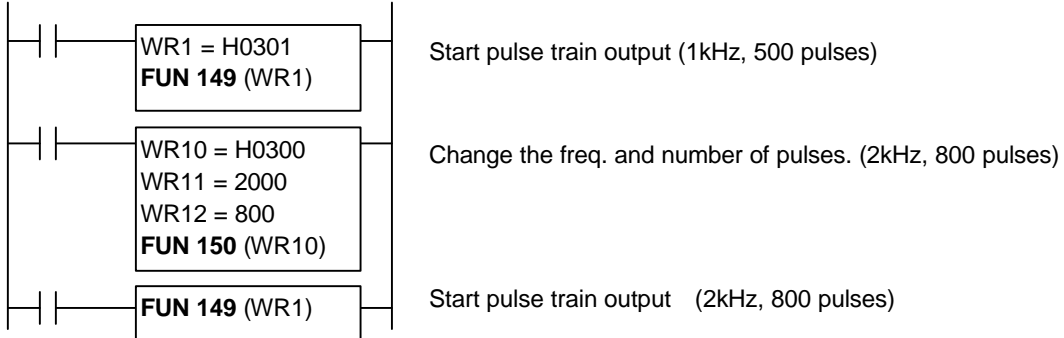

**Example 2**

**[ Configuration before CPU RUN ]**

WRF070 = 0 (Mode)  
 WRF071 = H0008 (I/O configuration)  
 R7F5 = 1 (Memory to CPU)

**[ Program ]**

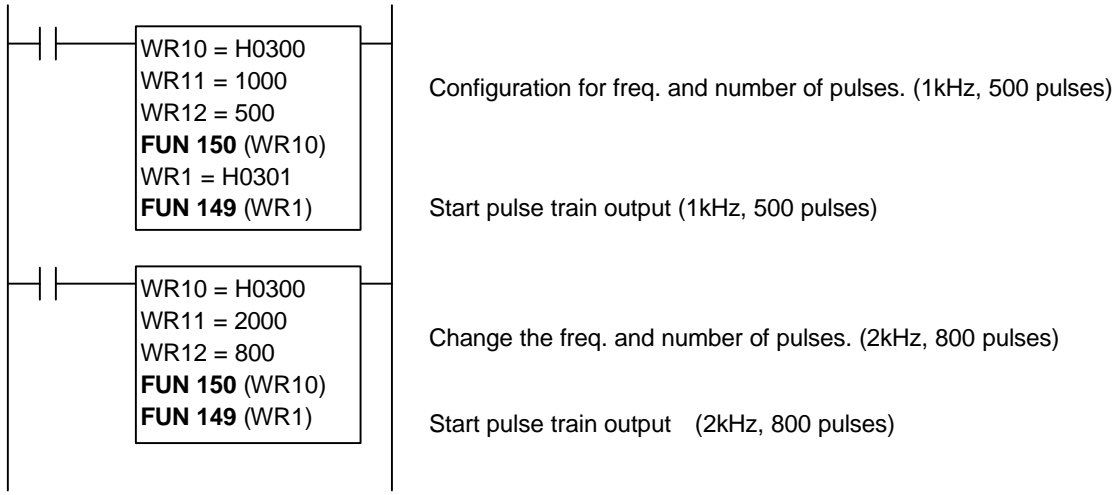

## 9. Encoder wiring

[ 24VDC is supplied from MICRO-EH ]

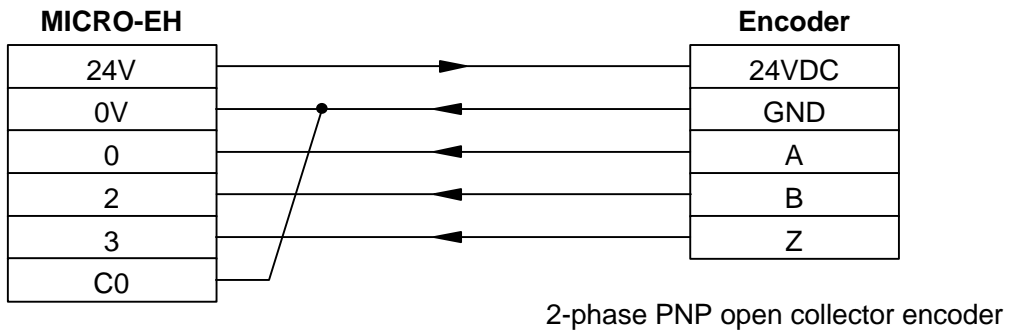

[ 24VDC is supplied from additional power supply ]

